

Trucothane Hammers

Trucothane Hammers are manufactured in the U.S.A. by Trusty-Cook, Inc. Trusty-Cook developed and introduced the original one-piece, hot-cast polyurethane hammer in 1970. They feature no mark, no spark protection for machinery, product and worker.

These hammers feature shot-filled canisters in the heads with convex faces which produce maximum dead blow, no-bounce action. An exclusive textured, non-slip, contoured, comfortable handle and a safety-flanged butt.

They will outlast rawhide, rubber, brass or nylon type heads 20 to 1.



A PRODUCT OF
TRUSTY-COOK
INCORPORATED

Warranty

TRUSTY-COOK, INC. WARRANTS EVERY TRUCOTHANE HAMMER AGAINST MANUFACTURER'S DEFECTS. SHOULD THE TOOL FAIL UNDER NORMAL USE WITHIN A PERIOD OF 2 YEARS, RETURN TO PLACE OF PURCHASE OR TRUSTY-COOK FOR FREE REPLACEMENT. WARRANTY VOID IF EXAMINATION REVEALS ALTERATION OR ABUSE OF TOOL.

Standard Heads

<u>Part #</u>	<u>Model</u>	<u>Ounces</u>	<u>Face Diameter</u>	<u>Overall Length</u>
121-08077	0	13	1 1/4"	10 1/8"
121-08078	1	21	1 3/4"	11 1/4"
121-08079	2	26	2"	12 3/4"
121-08080	3	45	2 1/4"	14 3/8"

Slimline Heads

<u>Part #</u>	<u>Model</u>	<u>Ounces</u>	<u>Face Diameter</u>	<u>Overall Length</u>
121-08081	S0	8	7/8"	9 3/8"
121-08082	S1	18	1 1/4"	10 5/8"
121-08083	S2	22	1 1/2"	12 1/8"
121-08084	S3	26	1 5/8"	12 3/4"

- INDEX
- PAINT
- HANDLEBARS
- STREET LEVERS
- FORK SEALS
- CABLES
- SUSPENSION
- ELECTRICAL
- FILTERS
- BRAKE LINES
- BRAKES
- CABLE MAKING SUPPLIES
- CONTROLS
- DUAL SPORT
- MANUALS
- FSO PRODUCTS
- EMGO
- DRIVE
- DISPLAY
- JETS
- BEARINGS
- EYEWEAR
- VINTAGE
- MIRRORS
- EUROPEAN
- KICKERS
- SHIFTERS
- MISC
- HARD PARTS
- SHOP TOOLS
- CHEMICALS
- TOOLS

INDEX

PAINT

HANDLEBARS

STREET LEVERS

FORK SEALS

CABLES

SUSPENSION

ELECTRICAL

FILTERS

BRAKE LINES

BRAKES

CABLE MAKING SUPPLIES

CONTROLS

DUAL SPORT

MANUALS

FSO PRODUCTS

EMGO

DRIVE

DISPLAY

JETS

BEARINGS

EYEWEAR

VINTAGE

MIRRORS

EUROPEAN

KICKERS

SHIFTERS

MISC

HARD PARTS

SHOP TOOLS

CHEMICALS

TOOLS

"MP" Metric Tool

121-08161

- The "MP" (Multi-Purpose) Tool is the perfect addition to your fanny pack
- The versatile tool is a must-have for on-the-trail repairs or adjustments
- Can be used to remove 8mm, 10mm, 12mm & 14mm bolts, #2 & #3 Phillips screws, small & medium straight-slot screws and 5 & 6 mm hex bolts
- Includes a 1/4" & 3/8" socket driver for using the 10mm & 12mm sockets included with the tool
- Tool can be enhanced by adding your own 1/4" - or 3/8"-drive socket attachments
- Includes convenient carrying case
- Replacement pieces sold separately

"MP" Metric Tool Replacement Parts

121-08162 #2 & #3 phillips bit

121-08163 5mm & 6mm hex bit

121-08164 small & medium
straight-slot screwdriver bit

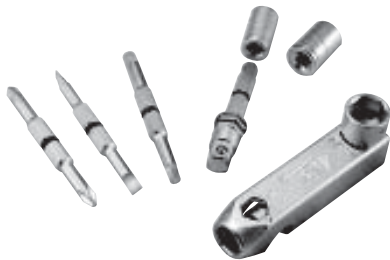

Spoke Wrenches

- Chrome-vanadium tool steel with satin-chrome finish
- Square-end openings which grip the spoke nipple on all four sides
- Offset slotted ends make it easy and quick to use
- 6mm and 6.3mm for most Japanese dirt & street bikes
- 6.5mm and 6.8mm for most European dirt bikes



121-08133 6mm & 6.3mm

121-08157 6.5mm & 6.8mm



Lead Hammers

520-00115

3 lbs. Lead Hammer

520-00117

5 lbs. Lead Hammer

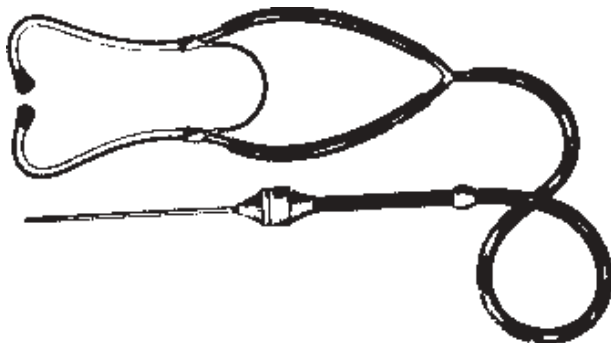

MECHANIC'S STETHOSCOPE

715-02000

This sensitive instrument quickly locates engine defects, worn gears, piston slap, body squeaks etc. Plastic ear phones shut out outside noises...6" needle probes suspected area and finds the spot where abnormal noise is concentrated. Shipping weight: 12 oz.

"Bead Buddy" Off-Road Tire Tool 121-08187

- Used to push the tire bead down into the drop center of the rim on off-road wheels while using tire tools to change tires
- Hook over spoke and push bead down on opposite side of tire from tire irons
- No more fighting to keep bead down while installing off-road tires



Torque Wrench Adapter 121-08134

- Chrome-vanadium tool steel with satin-chrome finish
- Properly torque two-stroke cylinder base nuts
- Will fit 12mm and 14mm nuts
- Extends the reach of 3/8" drive torque by 3"
- Chart supplied
- Check owners manual for proper torque specifications



Valve Core Remover 121-080183

- Made from hex stock
- Allows for easy removal and installation of standard valve cores in tubed or tubeless valve stems
- This will be the most borrowed tool in the service department!



Hydraulic Brake Bleeder 121-08143

- Make bleeding your brakes a one-person job.
- Instructions included
- Made in the U.S.A.



Impact Drivers & Bits

INDEX

PAINT

HANDLEBARS

STREET LEVERS

FORK SEALS

CABLES

SUSPENSION

ELECTRICAL

FILTERS

BRAKE LINES

BRAKES

CABLE MAKING SUPPLIES

CONTROLS

DUAL SPORT

MANUALS

FSO PRODUCTS

EMGO

DRIVE

DISPLAY

JETS

BEARINGS

EYEWEAR

VINTAGE

MIRRORS

EUROPEAN

KICKERS

SHIFTERS

MISC

HARD PARTS

SHOP TOOLS

CHEMICALS

TOOLS

Impact Driver

401-00038

Impact Driver, tightens screws on bolts on impact, or loosens frozen ones easily. Complete with 5/16" hex adaptor, four bits, and metal storage case. 3/8" square drive. Made in Taiwan.



'SOFT JAWS' FOR BENCH VISE

560-90610

One pair of aluminum "soft jaws" for 3" to 5" bench vises.

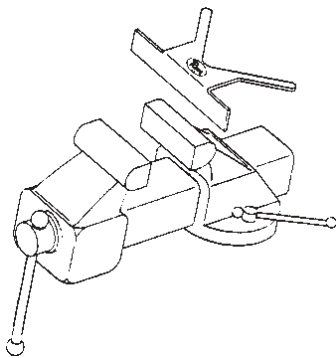

MITYVAC

154-04500

Cooling System Test Kit

The Mityvac Cooling System Test Kit features the all-metal Silverline Dual Converter pump, standard radiator adapter, temperature probe, needle probe and 24' of 1/4" I.D. tubing. The innovative Mityvac kit allows single-handed operation for checking cooling system temperature ranges, sensors, leaks etc. For motorcycles with small-neck radiators

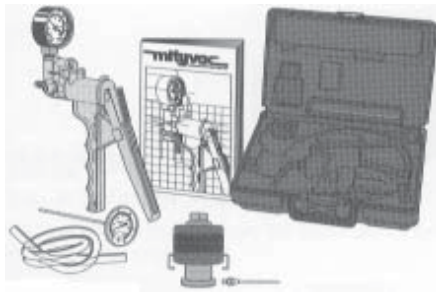

726-83800 Standard bit holder 3/8" sq. to 1/4" hex included in kit.



726-30801 Set screw holds bit of your choice. Allows quicker bit change over



726-44510 3/16" wide .034 thick standard slotted screw bit. 1/4" hex.



726-44520 7/32" wide .040 thick standard slotted screw bit. 1/4" hex.



726-44530 1/4" wide .042 thick standard slotted screw bit. 1/4" hex.

726-44020 Phillips #2 1/4" hex, 1" long

726-44030 Phillips #3 1/4" hex, 1" long

726-44040 Phillips #4 1/4" hex, 1-1/4" long

726-49210 Phillips #2 1/4" hex, 3-1/2" long

726-49301 Phillips #3 1/4" hex, 3.5" long

726-44035 Phillips #3 1/4" hex, 5" long



726-83200 Phillips #2 on 3/8" drive, 2-5/8" long

726-83300 Phillips #3 on 3/8" drive, 2-5/8" long

726-83400 Phillips #4 on 3/8" drive, 2-5/8" long



726-83500 3/8" drive adaptor for 5/16" hex insert bits



726-48020 #2 Phillips 5/16" hex insert bit, 1-1/4" long



726-48030 #3 Phillips 5/16" hex insert bit, 1-1/4" long



726-48040 #4 Phillips 5/16" hex insert bit, 1-1/4" long



726-48530 .042" flat blade 1/4" wide, 5/16" hex, 1-1/2" long



090-Hand Tools

Sockets & Wrenches



12 POINT 3/8 DRIVE SOCKETS	
INDIVIDUAL SOCKETS	
PART #	SIZE
701-45407	7mm
701-45408	8mm
701-45409	9mm
701-45410	10mm
701-45411	11mm
701-45412	12mm
701-45413	13mm
701-45414	14mm
701-45415	15mm
701-45416	16mm
701-45417	17mm
701-45418	18mm
701-45419	19mm
701-45420	20mm
701-45421	21mm
701-45422	22mm

3/8 DRIVE DEEP SOCKETS	
INDIVIDUAL SOCKETS	
PART #	SIZE
701-46210	10mm
701-46211	11mm
701-46212	12mm
701-46213	13mm
701-46214	14mm
701-46215	15mm
701-46217	17mm
701-46218	18mm
701-46219	19mm



Whitworth 12 POINT 3/8 DRIVE SOCKETS	
PART #	SIZE
701-45808	1/8"
701-45812	3/16"
701-45816	1/4"
701-45820	5/16"
701-45824	3/8"
701-45828	7/16"
701-45832	1/2"



HEXAGON 3/8 DRIVE SOCKETS	
INDIVIDUAL SOCKETS	
PART #	SIZE
701-45609	9mm
701-45610	10mm
701-45611	11mm
701-45612	12mm
701-45613	13mm
701-45614	14mm
701-45615	15mm
701-45616	16mm
701-45617	17mm
701-45618	18mm
701-45619	19mm

STAHLWILLE



HEXAGON 3/4 DRIVE SOCKETS	
INDIVIDUAL SOCKETS	
PART #	SIZE
701-55636	36mm
701-55641	41mm



12 POINT 1/2 DRIVE SOCKETS	
INDIVIDUAL SOCKETS	
PART #	SIZE
701-50420	20mm
701-50421	21mm
701-50422	22mm
701-50423	23mm
701-50424	24mm
701-50425	25mm
701-50427	27mm
701-50428	28mm
701-50429	29mm
701-50430	30mm
701-50432	32mm



704-00124

Set of hard chrome plated, ignition wrench. Thin for those hard to maneuver spots, but very strong. Contains: Four Wrenches, 4mm, 4.5mm, 5mm, 5.5mm.



704-01311

Set of hard chrome plated box and open end wrenches. Contains eleven end wrenches: 8, 9, 10, 11, 12, 13, 14, 15, 17, 19, 20mm.

COMBINATION WRENCHES					
INDIVIDUAL WRENCHES					
PART #	SIZE	PART #	SIZE	PART #	SIZE
701-13340	4mm	701-13411	11mm	701-13420	20mm
701-13345	4.5mm	701-13412	12mm	701-13421	21mm
701-13350	5mm	701-13413	13mm	701-13422	22mm
701-13355	5.5mm	701-13414	14mm	701-13423	23mm
701-13406	6mm	701-13415	15mm	701-13424	24mm
701-13407	7mm	701-13416	16mm	701-13427	27mm
701-13408	8mm	701-13417	17mm	701-13430	30mm
701-13409	9mm	701-13418	18mm	701-13432	32mm
701-13410	10mm	701-13419	19mm	701-13436	36mm

IGNITION WRENCHES	
INDIVIDUAL WRENCHES	
PART #	SIZE
701-12404	4mm x 4mm
701-12445	4.5mm x 5mm
701-12505	5mm x 5mm
701-12555	5.5mm x 5.5mm
701-12606	6mm x 6mm
701-12607	7mm x 7mm
701-12608	8mm x 8mm
701-12609	9mm x 9mm
701-12610	10mm x 10mm
701-12611	11mm x 11mm
701-12612	12mm x 12mm
701-12613	13mm x 13mm
701-12614	14mm x 14mm



- INDEX
- PAINT
- HANDLEBARS
- STREET LEVERS
- FORK SEALS
- CABLES
- SUSPENSION
- ELECTRICAL
- FILTERS
- BRAKE LINES
- BRAKES
- CABLE MAKING SUPPLIES
- CONTROLS
- DUAL SPORT
- MANUALS
- FSO PRODUCTS
- EMGO
- DRIVE
- DISPLAY
- JETS
- BEARINGS
- EYEWEAR
- VINTAGE
- MIRRORS
- EUROPEAN
- KICKERS
- SHIFTERS
- MISC
- HARD PARTS
- SHOP TOOLS
- CHEMICALS
- TOOLS

090-Hand Tools

Allen Sockets & T-Bar Sockets



Stahlwille

1/2 DRIVE ALLEN SOCKETS INDIVIDUAL SOCKETS	
PART #	SIZE
701-54210	10mm x LONG SHANK
701-54112	12mm
701-54114	14mm
701-54117	17mm



Stahlwille

3/8 DRIVE ALLEN SOCKETS INDIVIDUAL SOCKETS	
PART #	SIZE
701-49004	4mm
701-49005	5mm
701-49006	6mm
701-49007	7mm
701-49008	8mm
701-49010	10mm

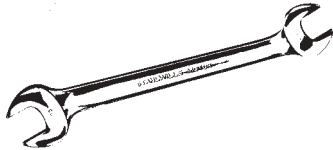

OPEN END WRENCHES INDIVIDUAL WRENCHES	
PART #	SIZE
701-10405	4mm x 5mm
701-10409	8mm x 9mm
701-10413	12mm x 13mm
701-10419	18mm x 19mm

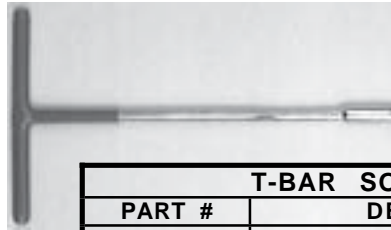

T-BAR SOCKETS	
PART #	DESCRIPTION
401-03860	HEX SOCKET DRIVER T-BAR 8mm
401-03861	HEX SOCKET DRIVER T-BAR 10mm
401-03862	HEX SOCKET DRIVER T-BAR 12mm
401-03863	HEX SOCKET DRIVER T-BAR 14mm

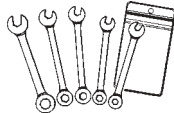

531-01210 MOTORCYCLE 5 PC. METRIC IGNITION WRENCH SET METRIC WRENCH SIZES	
BOX END	OPEN END
5mm	5mm
5.5mm	5.5mm
6mm	6mm
7mm	7mm
8mm	8mm



Stahlwille

1/2 DRIVE SPLINED ALLEN SOCKETS 12 POINT SPLINED INDIVIDUAL SOCKETS	
PART #	SIZE
701-54508	8mm Long (120mm)
701-54510	10mm Long (110mm)
701-54512	12mm Long (110mm)



Genuine Allen Standard Socket Bits	
PART NO.	SIZE
713-85170	2mm
713-85172	2.5mm
713-85174	3mm
713-85186	10mm

INDEX

PAINT

HANDLEBARS

STREET LEVERS

FORK SEALS

CABLES

SUSPENSION

ELECTRICAL

FILTERS

BRAKE LINES

BRAKES

CABLE MAKING SUPPLIES

CONTROLS

DUAL SPORT

MANUALS

FSO PRODUCTS

EMGO

DRIVE

DISPLAY

JETS

BEARINGS

EYEWEAR

VINTAGE

MIRRORS

EUROPEAN

KICKERS

SHIFTERS

MISC

HARD PARTS

SHOP TOOLS

CHEMICALS

TOOLS

090-6

(626) 792-7384
www.FlandersCompany.com



Fax: (626) 792-5341
www.FlandersCo.com

Rev. 10-11-01